



A G&\$%I (



A G%+* 'I (



&- &\$%&I &



DG\$!*%&\$'I &



DG\$&' 'I (

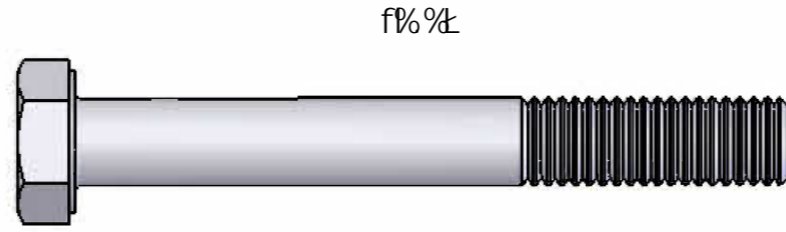

fP%L

: 6\$S' fA , 'I*)E1 ,

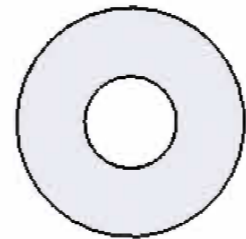

: K \$S&fA , E1 &\$



: B\$S* fA , E1 ,

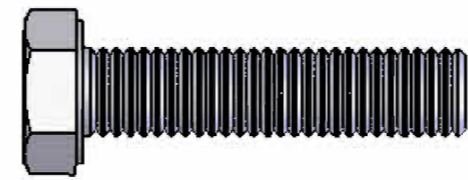

: G\$&' fA , 'I')E1 &



: G\$% fA , 'I' &)E1 &

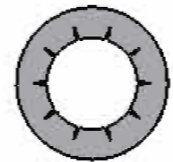

: K \$S- fA , E1 (

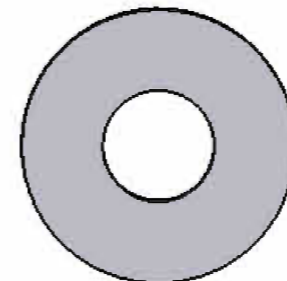

DG%)' 'I *

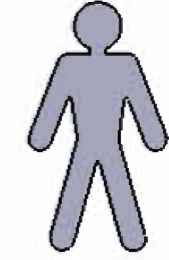
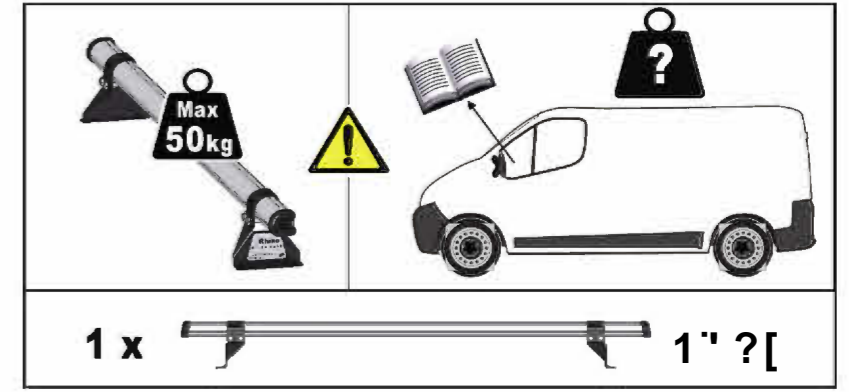

% a a 'I &

