

TELESTEPS 

No.1 in telescopic work tools



MADE IN SWEDEN

At Telesteps we care about you and our planet. The unique ladder you just unpacked is produced in the deep forest of Sweden. Thanks to our fully automatic production we can guarantee the same high quality and safety to every ladder we deliver. At the same time we minimize our impact on the planet's environment.



INSTRUCTION MANUAL

For Combi Line

EN 131
European Standard
Europäische Norm
Norme Européenne
Conforme aux exigences de sécurité



01.



02.



03.

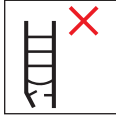

04.



05.



06.



07.



08.



09.



10.



11.



12.



13.

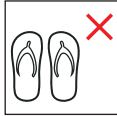

14.



15.

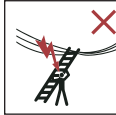

16.



EN ISO 7010-W012

17.



18.

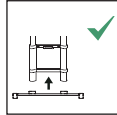

19.



20.

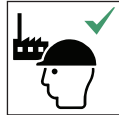

21.



22.

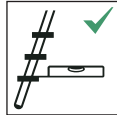

23.



24.

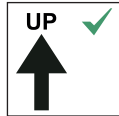

25.



26.



27.



28.



29.



30.



T1.



T2.

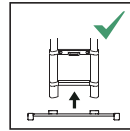

17 - ASSEMBLY STABILISER BAR

EN · For ladders > 3 m
ES · Para escaleras > 3m

FR · Pour les échelles > 3m
DE · Für Leitern > 3m

①

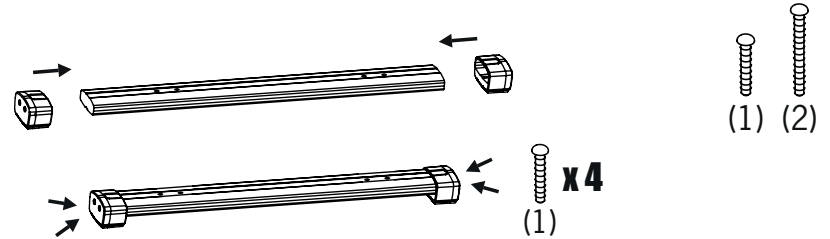

②

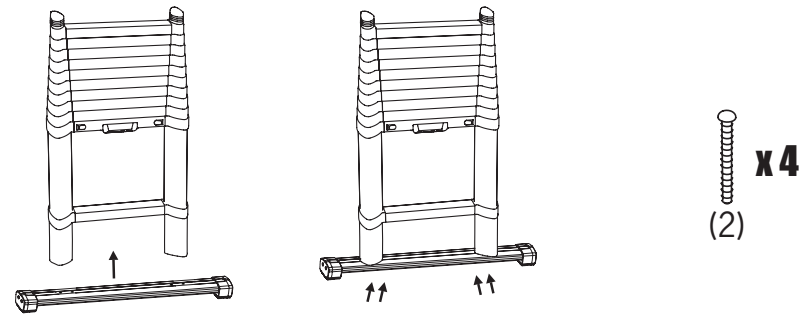

05 - USE ONLY ON LEVEL BASE

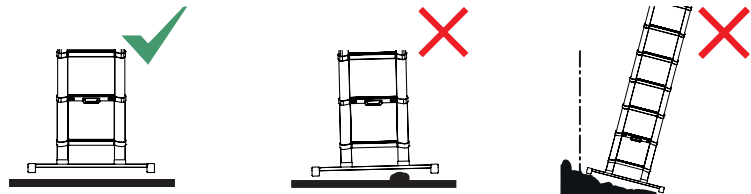

INSTRUCTIONS OF USE

EN · Open
ES · Abierto

FR · Ouvert
DE · Offen

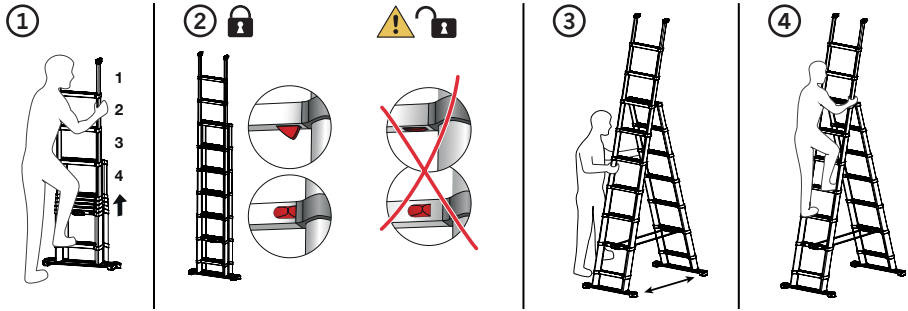

EN · Use as a leaning ladder
ES · Úselo como escalera inclinada

FR · Utiliser comme échelle penchée
DE · Verwendung als Anlegeleiter

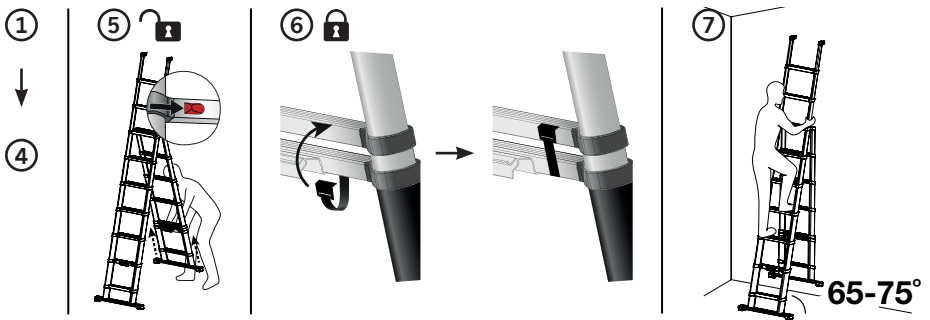

EN · Close ladder
ES · Cerrar escalera

FR · Fermer l'échelle
DE · Leiter zusammenfahren

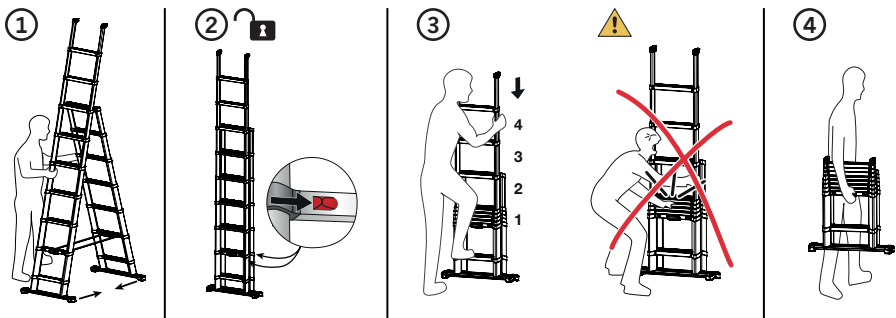

YEARLY INSPECTION

The Yearly Inspection is to create a repetitive yearly routine and review the condition of the Product.

- General data
- Visual inspection
- Functional inspection
- Service and maintenance
- Documentation

For more information, download our Maintenance Program at www.telesteps.se.

INSPECCIÓN ANUAL

La inspección anual debe de ser una rutina anual que se repita y con la que se revisen las condiciones en las que se encuentra el producto.

- Datos generales
- Inspección visual
- Inspección funcional
- Servicio y mantenimiento
- Documentación

Para más información, descargue nuestro Programa de Mantenimiento en www.telesteps.se.

PROGRAMME D'INSPECTION ANNUELLE

L'inspection annuelle consiste à créer une routine annuelle répétitive pour contrôler l'état du produit.

- Données générales
- Inspection visuelle
- Inspection fonctionnelle
- Service et maintenance
- Documentation

Pour plus d'informations, téléchargez notre programme de maintenance à l'adresse www.telesteps.se.

JÄHRLICHE INSPEKTION

Die jährliche Inspektion soll eine sich wiederholende Routine kreieren um den Zustand des Produkts überprüfen.

- Allgemeine Daten
- Visuelle Inspektion
- Funktionelle Inspektion
- Wartung und Instandhaltung
- Dokumentation

Für weitere Informationen können Sie unser Wartungsprogramm unter www.telesteps.se herunterladen.

Purchase date			
ID			
Year	Date	Note	Signature
1			
2			
3			
4			
5			
6			
7			
8			
9			
10			
11			
12			
13			
14			
15			



01. Warning, fall from ladder



02. Please see the user manual for more information



03. Inspect the ladder after delivery. Before every use visually check that the ladder is not damaged and is safe to use. Do not use a damaged ladder



04. Maximum total load, 150 kg



05. Do not use the ladder on uneven or unfirm base



06. Do not overreach



07. Do not erect ladder on contaminated ground



08. Maximum one user



09. Do not ascend or descend unless you are facing the ladder



10. Keep securing grip on ladder when ascending/descending. Take additional safety precautions if you cannot



11. Avoid work that imposes a sideways load on ladders, such as side-on drilling through solid materials



12. Do not carry equipment which is heavy or difficult to handle while using the ladder

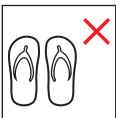

13. Do not wear unsuitable footwear when climbing the ladder



14. Do not use a ladder if you are not fit. Certain medical conditions or medication, alcohol or drug abuse could make ladder use unsafe



15. Warning, electricity hazard. Identify any electrical risks in the work area, such as overhead lines or other exposed electrical equipment, and do not use aluminum ladders where electrical risk occur



16. Do not use the ladder as a bridge



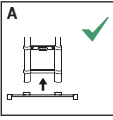

17. If a ladder is delivered with stabilizer bars and these bars should be fixed by the user before the first use this shall be described on the ladder and in the user instruction



18. Ladder for domestic use

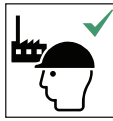
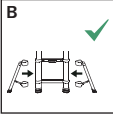

19. Ladder for professional use



20. Leaning ladders with rungs shall be used at the correct angle



21. Leaning ladders with steps shall be used that the steps are in a horizontal position



22. Ladders used for access to a higher level shall be extended at least 1 m above the landing point and secured, if necessary



23. Only use the ladder in the direction as indicated, only if necessary due to design of ladder



24. Do not lean the ladder against unsuitable surfaces

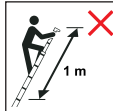

25. Do not stand on the last meter of a telescopic ladder



26. All locking mechanisms for all extended rungs/steps shall be checked and be locked before use



27. Do not bring your hands/fingers in rungarea when bringing the ladder in to its possible positions of use



28. Do not step off the side of standing ladder onto another surface.



29. Open the ladder fully before use.



30. Do not stand on the top two steps/rungs if handrails are not extended.



T1. For Germany TRBS 2121: At steps with a minimum depth of 80mm, work is allowed without restrictions up to standing height of 2m. Standing height between 2 to 5m allows temporary work up to 2h.

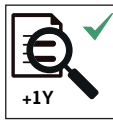

T2. Follow strictly the recommendation of a yearly inspection to create a repetitive routine and review the condition of the product. More information can be found in the Telesteps Maintenance Program.

Congratulations on your purchase of your Telesteps telescopic ladder. The unique design features ensure that a Telesteps ladder is safe and easy to use. Before use, please read the instructions carefully on how to use, manage and maintain your ladder.

BEFORE USE

- If the ladder is delivered with stabilizer bar(s), the bar(s) should be fixed by the user before use of the ladder.
- Inspect the ladder after delivery and before use to confirm condition and operation of all parts.
- Do not use a damaged ladder.
- Ensure that you are fit enough to use a ladder. Certain medical conditions or medication, alcohol or drug abuse could make ladder use unsafe.
- Ensure the ladder is suitable for the task.
- Remove any contamination from the ladder such as wet paint, mud, oil or snow.
- For professional use a risk assessment should be carried out respecting the legislation in the country of use.
- Identify any electrical risks in the work area, such as overhead lines or other exposed electrical equipment and do not use the ladder where electrical risks occur.
- Make sure all locking mechanisms for all extended rungs/steps are checked and locked before use.
- The ladder shall be used/stored in temperatures between -20 · +60 degrees °C.

BEFORE USE, ALWAYS CHECK:

- The stiles (uprights) are not bent, bowed, twisted, dented, cracked or corroded
- The telescopic tubes around the fixing points for other components are in good condition
- Fixings (usually rivets, screws or bolts) are not missing, loose or corroded
- Rungs are not missing, loose, excessively worn, corroded or damaged
- Hinges between front and rear sections are not damaged, loose or corroded
- Guide brackets are not missing, damaged, loose or corroded and engage properly on the mating stile
- Rubber feet and end caps are not missing, loose, excessively worn, corroded or damaged
- The entire ladder is free from contaminants (e.g. dirt, mud, paint, oil or grease)
- Locking catches are not damaged or corroded and function correctly

If any of the above checks cannot be fully satisfied, you should NOT use the ladder.

CLEANING

For reasons of safety and functionality, the telescopic product must always be kept clean, particularly the telescopic tubes and rungs. Dirt, filings, paint spots, glue etc. must be cleaned after each use, and before the ladder is closed. If your ladder is soaking wet, fully extend the ladder, wipe off and keep it extended until the ladder is completely dry. Our Maintenance Kit includes both a unique melamine cleaning sponge and a microfiber towel to solve these tasks easily.

SERVICE & MAINTENANCE

Any service or repair work must always be carried out by an authorized service workshop, which determines suitable action in each individual case. Please contact the producer or distributor for service & maintenance.

If rubber feet or end-caps are getting worn, replace these for optimal safety. Never use the ladder without rubber feet (slip protection) and end-caps to prevent dust, metal chips or similar from getting into the tubes. New feet/end caps can be obtained from retailers. Only original spare parts may be used for safety reasons.

In case of service or repair contact your retailer to find the location of your nearest authorized service partner.

TRANSPORT & STORAGE

Always carry and transport the ladder completely closed and compacted to protect the telescopic tubes from any damage that can impair the functionality of the ladder.

The ladder shall be stored:

- Away from areas where its condition could deteriorate more rapidly (e.g. dampness, excessive heat, exposed to the elements)
- Where it cannot be damaged by vehicles, heavy objects, or contaminants.
- Where it cannot cause a trip hazard or an obstruction.
- Where it cannot be easily used for criminal purposes.
- Permanently positioned (e.g. scaffolding), or/and secured against unauthorized climbing (e.g. by children)

GUARANTEE CONDITIONS

The manufacturer guarantees that the product is free from material or manufacturing faults. If material or manufacturing faults, or damage due to material or manufacturing faults, can be proven, the buyer is entitled to have the product repaired or replaced in accordance with the local laws concerning sales of consumer goods in the country of purchase.

The manufacturer is responsible for faults in the product, for two years from the purchase date.

The manufacturer is not responsible for faults in the product, if it is clear that the fault is due to it:

- Not being used as described in the instructions.
- Not being cleaned, cared for, maintained, stored or transported in accordance with the instructions.
- Being rebuilt, modified or subjected to other external damage or accident unintentionally being damaged by any object or substance.
- Being overloaded
- Being repaired by an unauthorized service partner or if non-original spare parts have been used.
- Being incorrectly set up.

Normal wear and tear are not considered as faults.

Proof of purchase must be presented for any guarantee claims. If the purchaser wishes to make a claim regarding a fault, the retailer must be notified of the fault within a reasonable time after the fault has been discovered, or within the time period regulated by the country of purchase.

Felicitări pentru achiziționarea scării dvs. telescopice Telesteps. Caracteristicile unice de construcție conferă scărilor Telesteps siguranță și comoditate în utilizare. Înainte de utilizare, citiți cu atenție instrucțiunile privind utilizarea, gestionarea și întreținerea scării dvs.

ÎNAINTE DE UTILIZARE

- Dacă scara este livrată cu bare stabilizatoare, acestea trebuie fixate de către utilizator înainte de utilizarea scării.
- Înainte de prima utilizare, după livrare, verificați dacă scara este în stare bună și dacă toate componentele funcționează.
- Nu folosiți o scară deteriorată.
- Asigurați-vă că starea dvs. vă permite să utilizați scara. Anumite afecțiuni sau medicamente, abuzul de alcool sau de droguri ar putea pune sub semnul nesiguranței utilizarea scării.
- Asigurați-vă că scara este potrivită pentru activitatea desfășurată.
- Îndepărtați de pe scară orice impurități precum vopsea neuscată, noroi, ulei sau zăpadă.
- Pentru utilizarea profesională se va realiza o analiză a riscurilor, în conformitate cu legislația țării în care se folosește scara.
- Identificați orice riscuri electrice din zona de lucru, precum cablurile electrice suspendate sau alte echipamente electrice expuse, și nu folosiți scara în locurile în care pot apărea riscuri electrice.
- Asigurați-vă că ați verificat și ați blocat toate mecanismele de blocare de la toate treptele extinse.
- Scara va fi utilizată/depozitată la temperaturi între -20 – +60 °C.

ÎNAINTE DE UTILIZARE, VERIFICAȚI ÎNTOTDEAUNA DACĂ

- Lateralele (montanții) nu sunt îndoite, curbate, răsucite, crestate, crăpate sau corodate
- Tuburile telescopice sunt intacte în punctele de prindere la alte componente
- Elementele de prindere (de regulă nituri, șuruburi sau bolțuri) nu lipsesc, nu sunt slăbite sau corodate
- Treptele nu lipsesc, nu sunt slăbite, excesiv de uzate, corodate sau deteriorate
- Balamalele care cuplează secțiunile din față și din spate nu sunt deteriorate, slăbite sau corodate
- Colierele de ghidare nu lipsesc, nu sunt deteriorate, slăbite sau corodate și dacă se cuplează corect pe laterala corespunzătoare
- Picioarele de cauciuc și capacele de protecție nu lipsesc, nu sunt slăbite, excesiv de uzate, corodate sau deteriorate
- Întreaga scară este curată (de exemplu, impurități, noroi, vopsea, ulei sau grăsime)
- Elementele de blocare nu sunt deteriorate sau corodate și dacă funcționează corect

NU folosiți scara dacă descoperiți nereguli în urma oricăreia din verificările de mai sus.

CURĂȚAREA

Din motive de siguranță și funcționalitate, produsul telescopic trebuie păstrat întotdeauna curat, în special tuburile și treptele telescopice. Murdăria, piliturile, petele de vopsea, lipici etc. trebuie curățate după fiecare utilizare și înainte ca scara să fie închisă. Dacă scara dvs. este umedă, extindeți complet scara, ștergeți-o și mențineți-o extinsă până când scara este complet uscată. Setul nostru de întreținere include atât un burete unic de curățat cu melamină, cât și un prosop din microfibră pentru a rezolva cu ușurință aceste sarcini.

SERVICE ȘI ÎNTREȚINERE

Orice operațiuni de service sau reparații vor fi realizate întotdeauna de un atelier de service autorizat, care va stabili măsurile adecvate pentru fiecare caz în parte. Contactați producătorul sau distribuitorul pentru service și întreținere.

Dacă picioarele de cauciuc sau capacele de protecție se uzează, înlocuiți-le pentru o siguranță optimă.

Nu folosiți niciodată scara fără picioarele din cauciuc (antialunecare) și capacele de protecție, pentru a preveni

pătrunderea prafului, a așchiilor metalice sau a altor corpuri străine similare în interiorul tuburilor. Picioare/capace noi pot fi obținute de la distribuitori. Din motive de siguranță, pot fi folosite numai piese de schimb originale.

În caz de service sau reparații contactați distribuitorul dvs. pentru a afla adresa celui mai apropiat partener de service autorizat.

TRANSPORT ȘI DEPOZITARE

Transportați întotdeauna scara complet închisă și compactată pentru a proteja tuburile telescopice împotriva oricăror deteriorări care ar putea afecta funcționalitatea scării.

Scara va fi depozitată:

- Departe de zonele în care starea sa fizică s-ar putea deteriora mai rapid (de exemplu, umezeală, căldură excesivă, expunere la intemperii)
- Într-un loc în care să nu poată fi deteriorată de vehicule, obiecte grele sau impurități.
- Într-un loc în care să nu genereze un pericol de împiedicare sau de blocare.
- Într-un loc în care să nu poate fi folosită în scopuri infracționale.
- Permanent poziționată (de exemplu, pe schele), sau/și asigurată împotriva utilizării neautorizate
- (de exemplu, de către copii)

CONDIȚII DE GARANȚIE

Producătorul garantează că produsul nu prezintă defecte de fabricație sau la nivelul materialelor. Dacă defectele de fabricație sau de la nivelul materialelor, ori deteriorările produse de defecte de fabricație sau de la nivelul materialelor pot fi demonstrate, cumpărătorul are dreptul să obțină repararea sau înlocuirea produsului, în conformitate cu legislația locală privind comercializarea bunurilor de consum, valabile în țara în care s-a achiziționat produsul.

Producătorul este responsabil de defectele identificate la nivelul produsului, timp de doi ani de la data cumpărării.

Producătorul nu este responsabil de defectele identificate la nivelul produsului, dacă se dovedește că defectul este determinat de următoarele:

- Produsul nu a fost utilizat în modul descris în instrucțiuni.
- Produsul nu a fost curățat, îngrijit, întreținut, depozitat sau transportat conform instrucțiunilor.
- Produsul a fost refăcut, modificat sau supus altor deteriorări sau accidente externe, fiind deteriorat în mod neintenționat de obiecte sau substanțe.
- Produsul a fost suprasolicitat
- Produsul a fost reparat de un partener de service neautorizat sau s-au folosit alte piese de schimb decât cele originale.
- Produsul a fost instalat greșit.

Uzura fizică și morală nu sunt considerate defecte.

Pentru orice cerere de garanție trebuie prezentată dovada achiziționării. Dacă cumpărătorul dorește să formuleze o reclamație cu privire la un defect, distribuitorul trebuie să fie informat de existența defectului într-un interval de timp rezonabil de la data descoperirii defectului sau în intervalul de timp reglementat de țara în care s-a achiziționat produsul.



Many years ago we created an icon in the world of ladders and today we are recognized as the world leader in telescopic work tools. With our R&D and world class production based in Sweden, our brand and products are renowned for its quality and design by our users worldwide, ensuring we always put safety and quality first.



Telesteps AB, Box 362, 573 24 Tranås, Sweden
info@telesteps.com | www.telesteps.com